

# 10FT BACKLIT "PREMIUM ARCH" SEG TRADE SHOW DISPLAY WITH PARTITION

## ASSEMBLY INSTRUCTION



Indoor Display  
Solution



User  
Friendly



Cutting-Edge  
Design

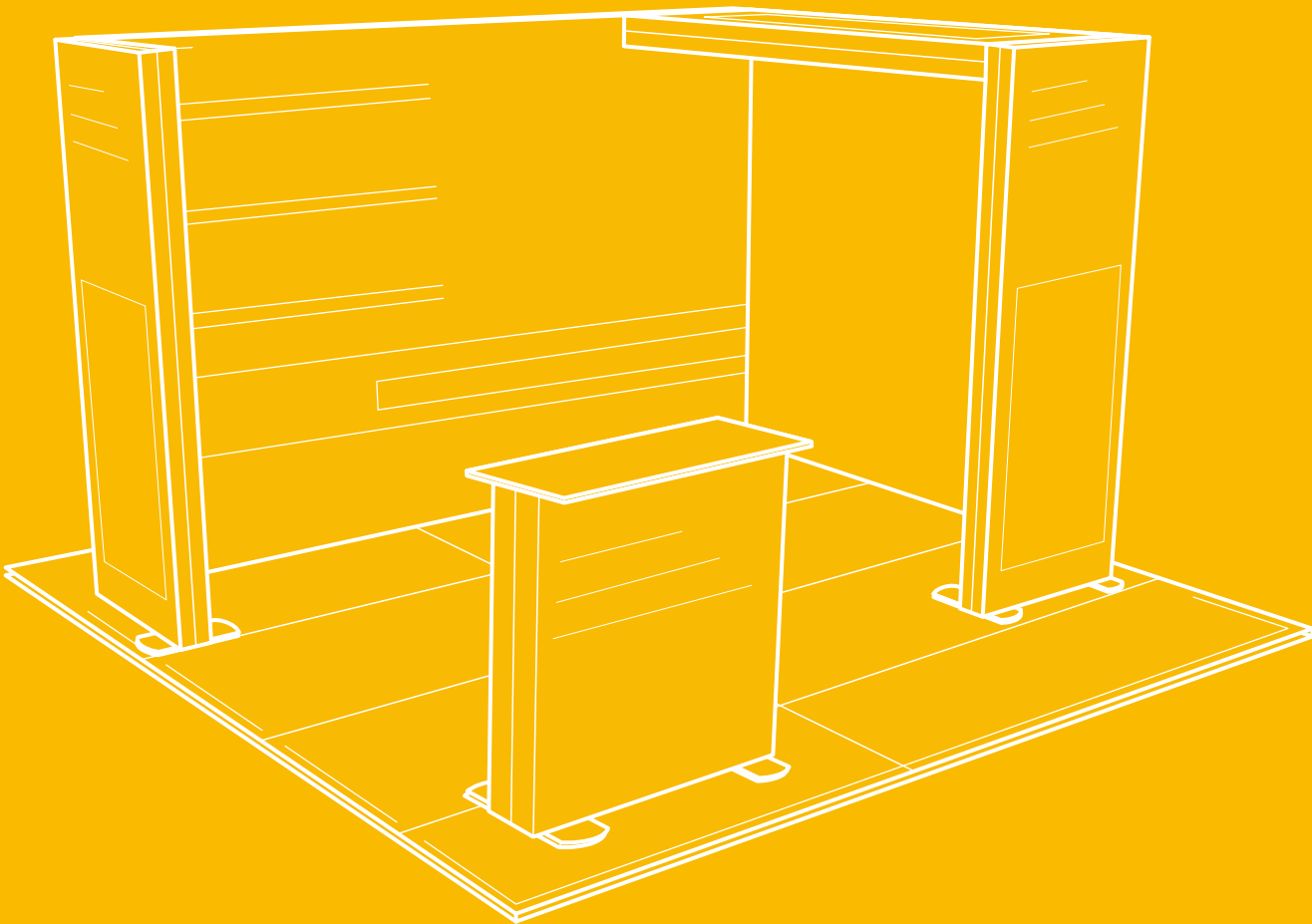

# Components.

---

- 01 — Profile with LED Stripe
- 02 — Side Profile with Cable
- 03 — Side Profile without Cable
- 04 — Inner Strut

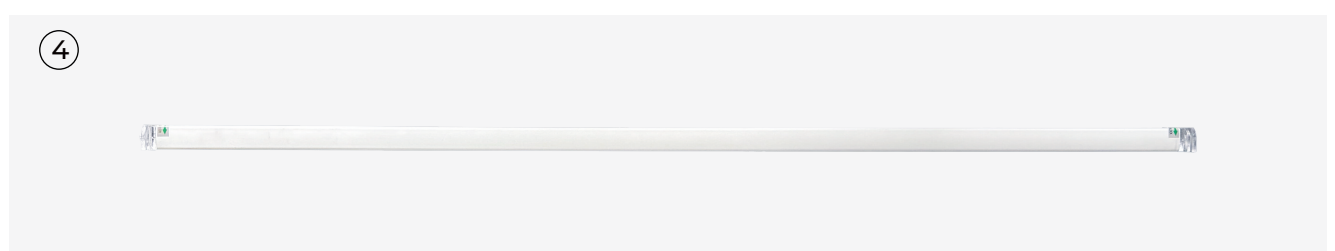
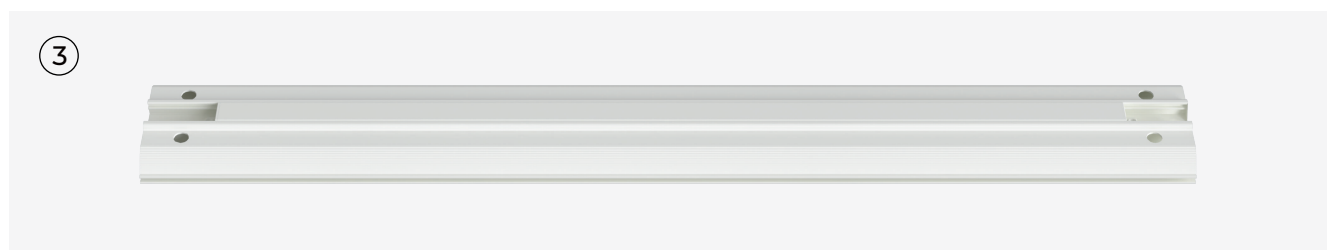
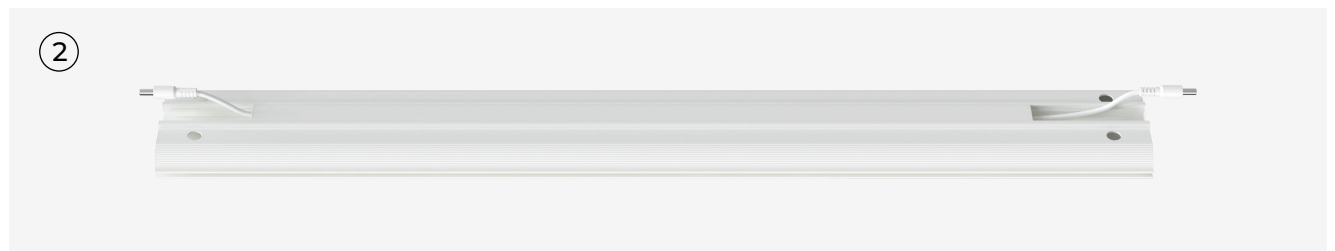

- 05** ————— Base Plate
- 06** ————— Bottom Connector
- 07** ————— Side Connector
- 08** ————— Corner Connector
- 09** ————— Middle Feet
- 10** ————— Middle Cross Connector
- 11** ————— Connecting Cable
- 12** ————— Power Supply with Device Plugin

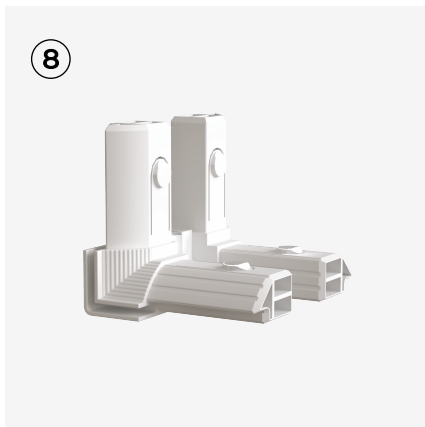

# 10ft SEG Backlit Backwall Assembly Instruction

Applies to: 10ft x 8.2ft

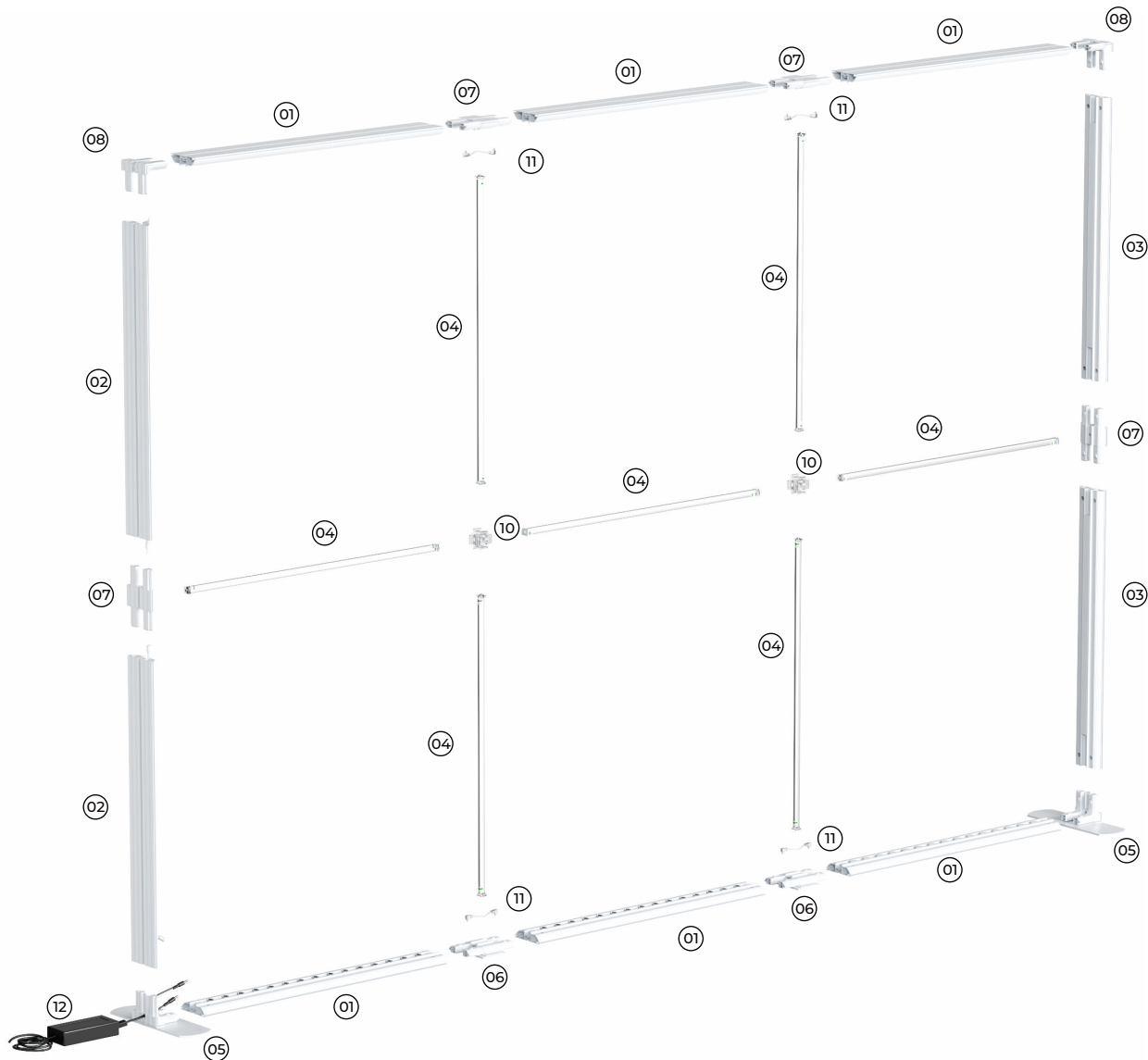

**01** Profile with LED Stripe (x6)

**02** Profile with Cable (x2)

**03** Profile without Cable (x2)

**04** Inner Strut (x7)

**05** Base Plate (x2)

**06** Bottom Connector (x2)

**07** Side Connector (x4)

**08** Corner Connector (x2)

**10** Middle Cross Connector (x2)

**11** Connecting Cable (x4)

**12** Power Supply with Device Plugin (x2)

## Storage & Care:

Store in a cool dry location. Clean hardware with a damp cloth. Machine wash the graphics in cold water on a gently cycle. Air dry only. Use a steamer for wrinkles. Never dry-clean.

# 2.8ft SEG Backlit Backwall Assembly Instruction

Applies to: 2.8ft x 8.2ft

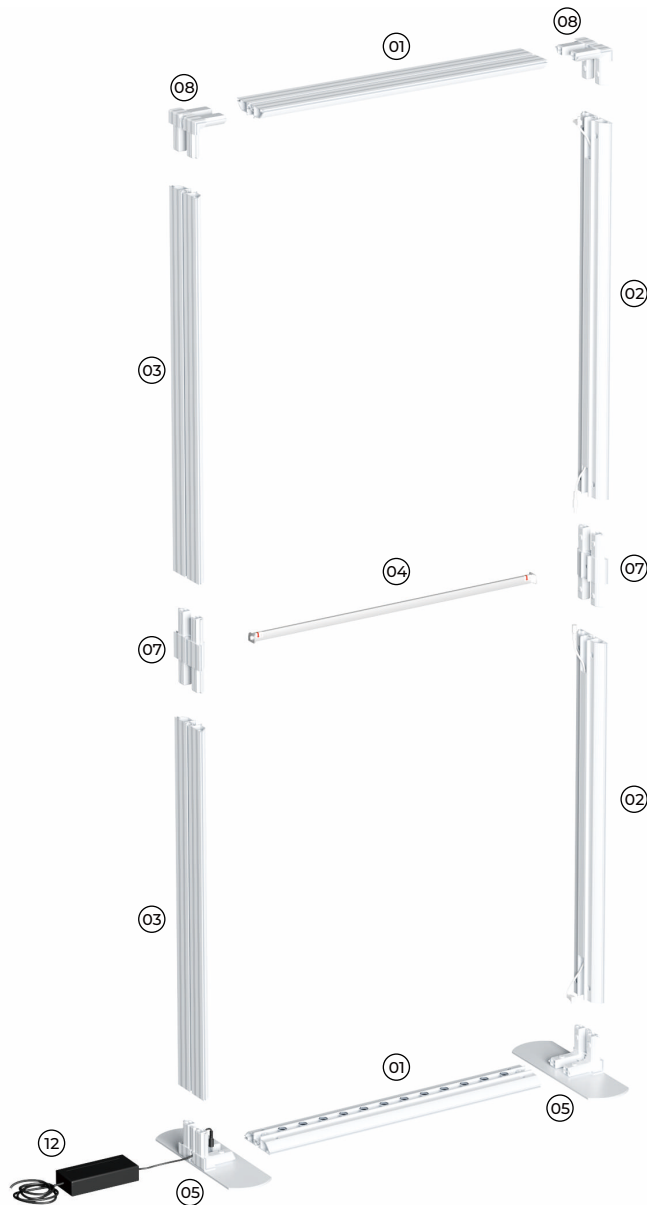

- |  |  |
|--|--|
| <b>01</b> Profile with LED Stripe (x2) | <b>05</b> Base Plate (x2)                    |
| <b>02</b> Profile with Cable (x2)      | <b>07</b> Side Connector (x2)                |
| <b>03</b> Profile without Cable (x2)   | <b>08</b> Corner Connector (x2)              |
| <b>04</b> Inner Strut (x1)             | <b>12</b> Power Supply with Device Plug (x2) |

## Storage & Care:

Store in a cool dry location. Clean hardware with a damp cloth. Machine wash the graphics in cold water on a gently cycle. Air dry only. Use a steamer for wrinkles. Never dry-clean.

# 10ft SEG Backlit Counter Assembly Instruction

Applies to: 3.3ft x 3.3ft



**01** Profile with LED Stripe (x2)

**02** Profile with Cable (x2)

**03** Profile without Cable (x2)

**05** Base Plate (x2)

**08** Corner Connector (x2)

**12** Power Supply with Device Plugin (x1)

**13** Tabletop Panel with LED Stripes (x1)

## Storage & Care:

Store in a cool dry location. Clean hardware with a damp cloth. Machine wash the graphics in cold water on a gently cycle. Air dry only. Use a steamer for wrinkles. Never dry-clean.